



Gruppi di teste con coltellini, intercambiabili tra loro per la realizzazione di parchetti e perline su macchine scorniciatrici. Gli utensili sono regolabili mediante anelli distanziali che permettono di ottenere gli spessori e i profili desiderati. I gruppi sono corredati da bussole di accoppiamento per l'assemblaggio delle singole teste.

Set of steel cutters mounted on assembly bush for producing up to 17 different variations of tongue and groove profiles on moulding machines, suitable for mechanical feed.

Anwendung

Fräsersatz zur Herstellung von Nut- und Federprofilen auf mehrspindeligen Kehlautomaten.

Technische Daten







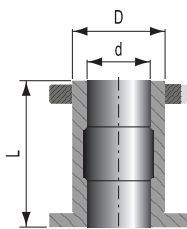

Fräskörper aus Stahl auf Büchse montiert mit Profil- und Wendemessern aus Hartmetall, 24 untereinander austauschbare Einzelfräser für die Herstellung von bis zu 17 unterschiedlichen Profilvariationen, für mechanische Vorschübe geeignet.

Ø D [mm]	B [mm]	Ø d [mm]	Z	V	I	S	Nr.	RPM min-max	Art. Nr.	€
140	15	50	4	2			1	10000	TH20FM01	
140	15	50	4	2			2	10000	TH20FM02	
127	12	50	2			2	3	10000	TH20FM03	
155	20	50	4		2		4	10000	TH20FM25	
155	20	50	4		2		5	10000	TH20FM26	
139	15	50	4	2			6	10000	TH20FM06	
175	15	50	4	2			7	8000	TH20FM07	
155	20	50	4		2		8	9000	TH20FM27	
160	15	50	4	2			9	9000	TH20FM09	
155	20	50	4		2		10	9000	TH20FM28	
168	20	50	4		2		11	9500	TH20FM11	
149	15	50	4	2			12	9500	TH20FM12	
168	20	50	4		2		13	8500	TH20FM13	
168	20	50	4		2		14	8500	TH20FM14	
154	12	50	2				15	9000	TH20FM15	
154	12	50	2				16	9000	TH20FM16	
122	12	50	2			2	17	10000	TH20FM17	
160	20	50	4		2		18	10000	TH20FM18	
160	20	50	4		2		19	10000	TH20FM19	
160	20	50	4		2		20	9000	TH20FM20	
160	20	50	4		2		21	9000	TH20FM21	
175	20	50	4	2			22	8000	TH20FM22	
160	20	50	4		2		23	9000	TH20FM23	
195	20	50	4				24	7000	TH20FM24	

Bussole di accoppiamento / Assembly bushes / Spannbüchsen



	D x L x d [mm]	Art. Nr.	€
dx	50 x 105 x 30	1002040030	
	50 x 105 x 35	1002050035	
	50 x 105 x 40	1002060040	
sx	50 x 105 x 30	1002140030	
	50 x 105 x 35	1002150035	
	50 x 105 x 40	1002160040	

Ricambi / Spare Parts / Ersatzteile									
TH20FM01 TH20FM02 TH20FM06	Art. Nr.	600003	350004	502404	600201	500002			
	Dim.	15 x 12 x 1,5	11 mm	M7 x 19	14 x 14 x 2	M5 x 7			
	Pcs								
	€								
TH20FM07 TH20FM09 TH20FM12	Art. Nr.	600003	350004	502402	600201	500002		500201	600601/02
	Dim.	15 x 12 x 1,5	11 mm	M7 x 21	14 x 14 x 2	M5 x 7		M6 x 21	27 x 6 x 14
	Pcs								
	€								
TH20FM03 TH20FM17	Art. Nr.	600002	350023	502403				500205	
	Dim.	12 x 12 x 1,5	9 mm	M5 x 18				M6 x 15	
	Pcs								
	€								
TH20FM18	Art. Nr.	600004	350005	502402			600704	500205	
	Dim.	20 x 12 x 1,5	16 mm	M7 x 21			48 x 4 x 16	M6 x 15	
	Pcs								
	€								
TH20FM19	Art. Nr.	600004	350005	502402			600703	500205	
	Dim.	20 x 12 x 1,5	16 mm	M7 x 21			48 x 4 x 16	M6 x 15	
	Pcs								
	€								
TH20FM13 TH20FM14 TH20FM20 TH20FM21	Art. Nr.	600004	350005	502404			600703	500205	
	Dim.	20 x 12 x 1,5	16 mm	M7 x 19			48 x 4 x 16	M6 x 15	
	Pcs								
	€								
TH20FM11	Art. Nr.	600004	350005	502402			600710		
	Dim.	20 x 12 x 1,5	16 mm	M7 x 21			60 x 4 x 16		
	Pcs								
	€								
TH20FM15 TH20FM16	Art. Nr.	600002	350023	502403					
	Dim.	12 x 12 x 1,5	9 mm	M5 x 18					
	Pcs								
	€								
TH20FM22	Art. Nr.	601461	350024	502402	600201	500002			
	Dim.	19,8 x 22 x 2	17,6 mm	M7 x 21	14 x 14 x 2	M5 x 7			
	Pcs								
	€								
TH20FM23	Art. Nr.	601462	350005	502404			600703	500205	
	Dim.	19,8 x 22 x 2	16 mm	M7 x 19			48 x 4 x 16	M6 x 15	
	Pcs								
	€								
TH20FM24	Art. Nr.	601463	350082	502402					
	Dim.	19,8 x 34 x 2	16,5 mm	M7 x 21					
	Pcs								
	€								
TH20FM25 TH20FM26	Art. Nr.	600004	350005	502402			600766	500205	
	Dim.	20 x 12 x 1,5	16 mm	M7 x 21			37 x 4 x 16	M6 x 15	
	Pcs								
	€								
TH20FM27	Art. Nr.	600004	350005	502404	600201	500002	600766	500205	
	Dim.	20 x 12 x 1,5	16 mm	M7 x 19	14 x 14 x 2	M5 x 7	37 x 4 x 16	M6 x 15	
	Pcs								
	€								
TH20FM28	Art. Nr.	600004	350005	502404			600766	500205	
	Dim.	20 x 12 x 1,5	16 mm	M7 x 19			37 x 4 x 16	M6 x 15	
	Pcs								
	€								

Profili – ridotta profondità di incastro / Profiles - short tongue / Profilbeispiele - kurze Feder

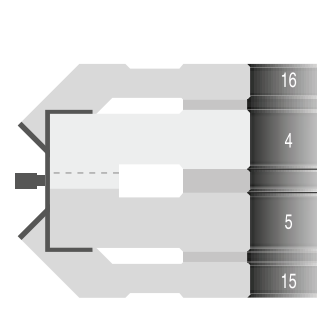
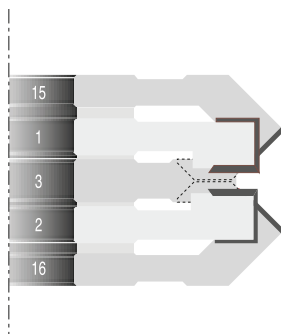
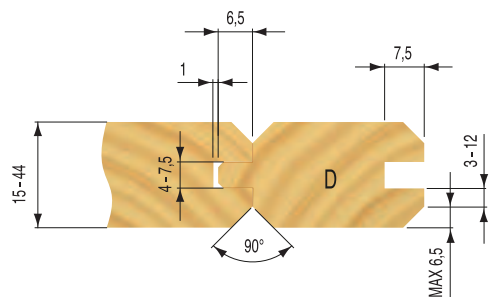
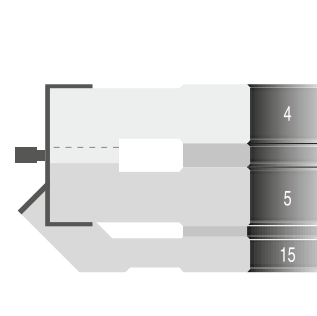
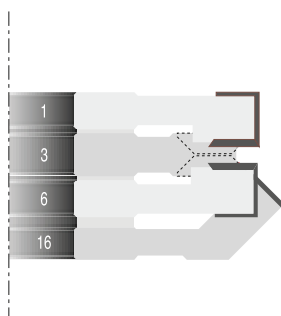
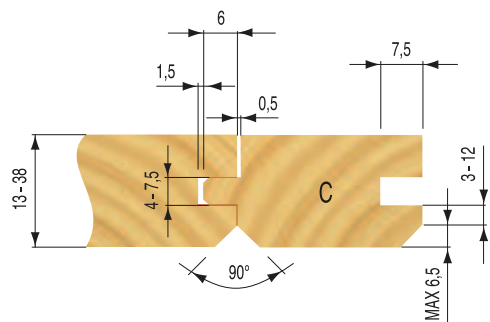
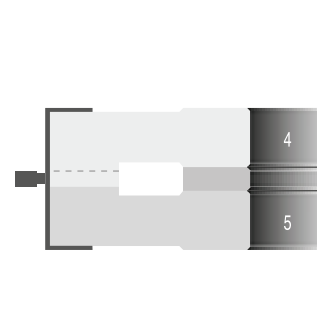
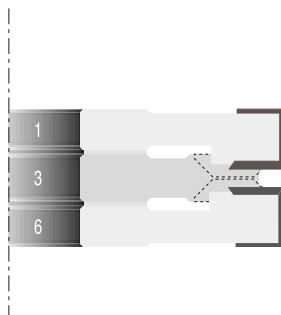
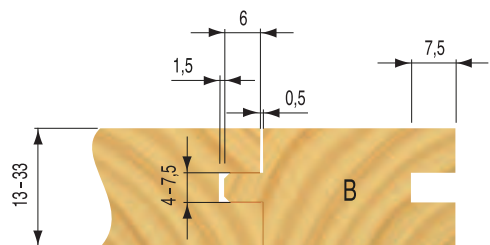
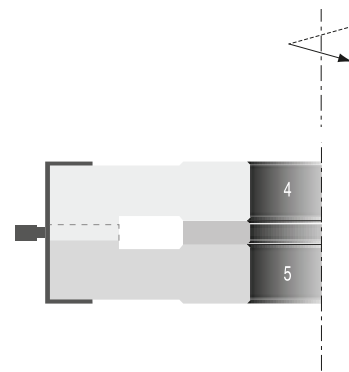
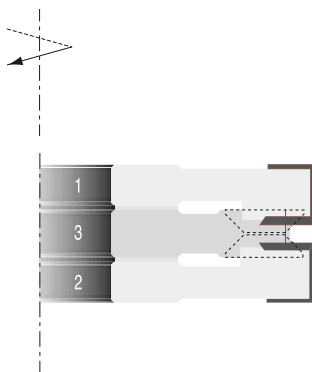
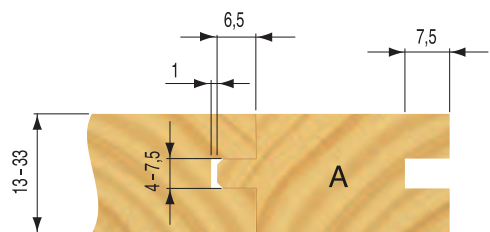

Profili – ridotta profondità di incastro / Profiles - short tongue / Profilbeispiele - kurze Feder

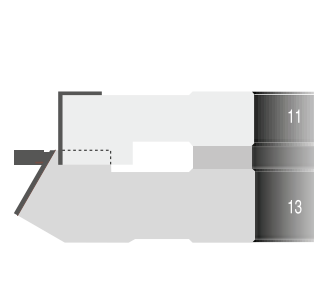
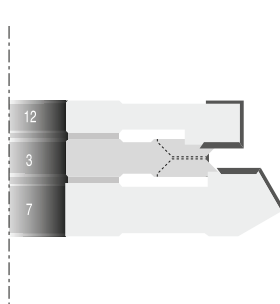
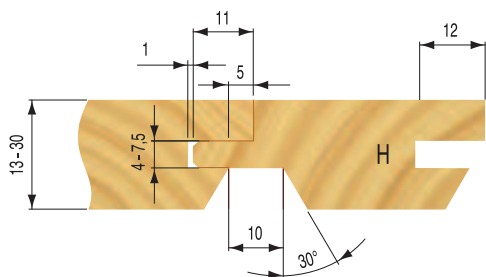
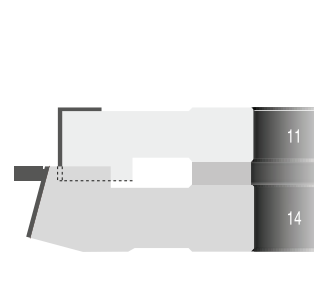
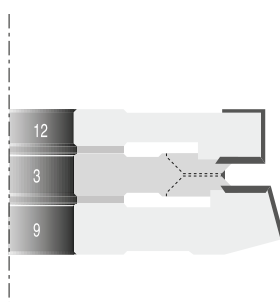
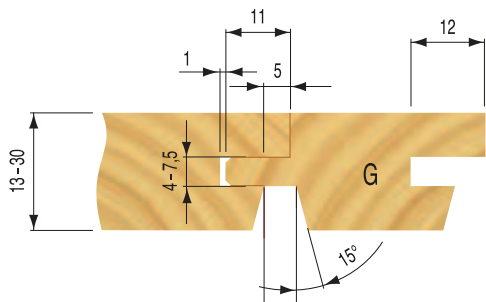
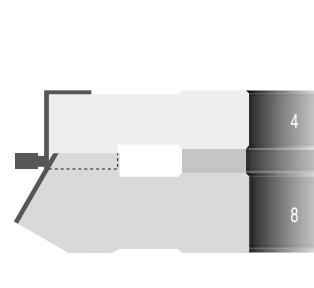
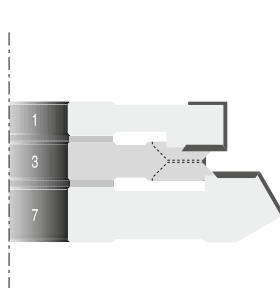
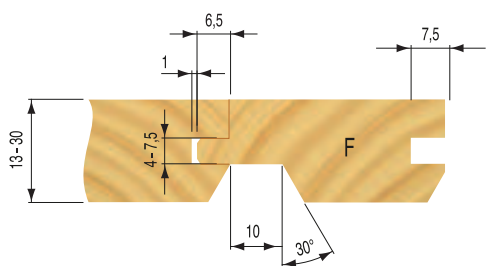
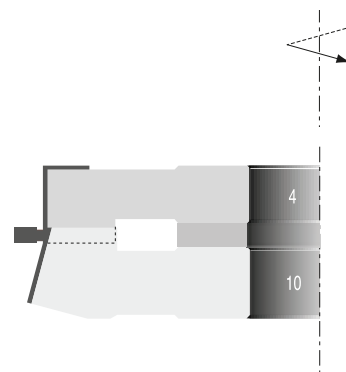
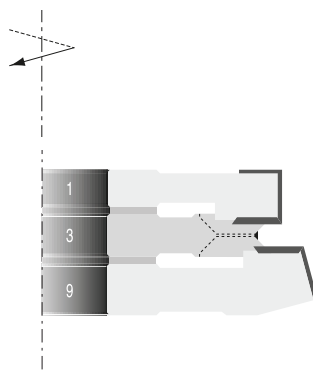
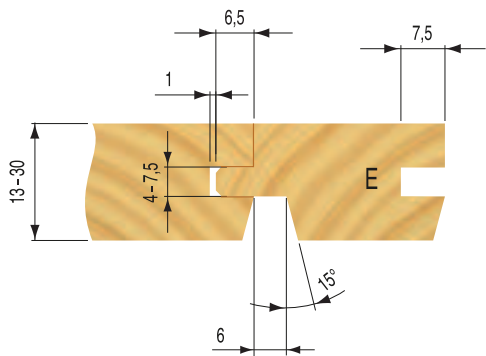

Profili – elevata profondità di incastro / Profiles - long tongue / Profilbeispiele - lange Feder

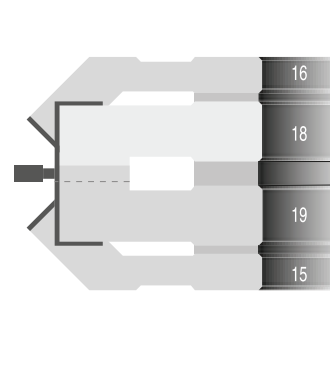
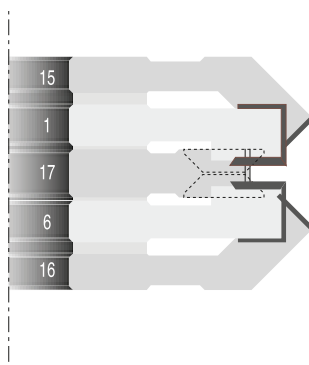
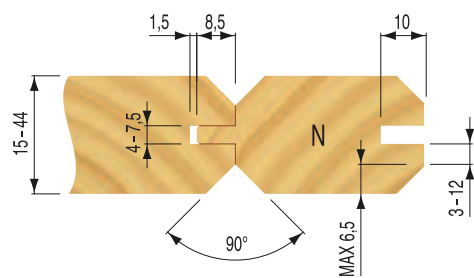
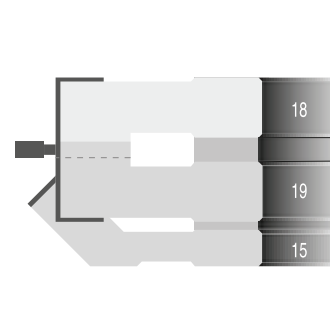
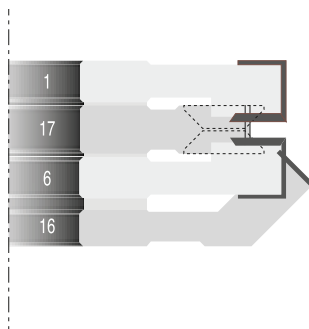
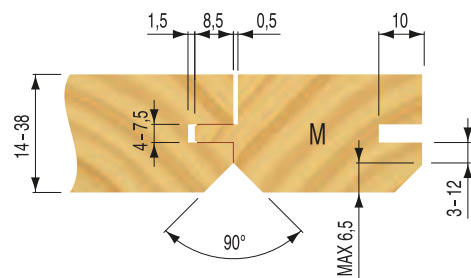
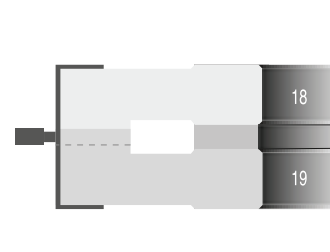
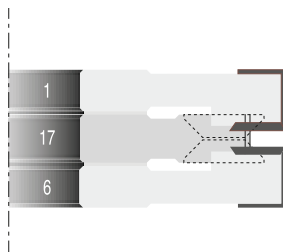
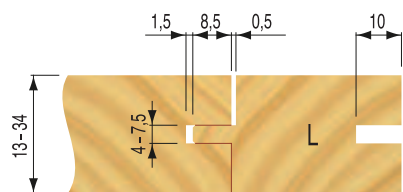
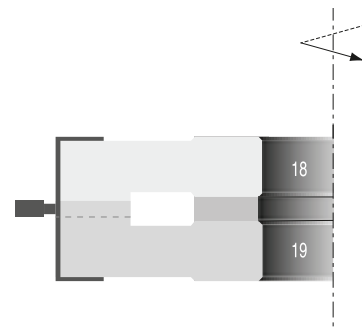
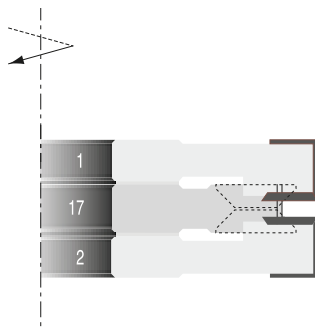
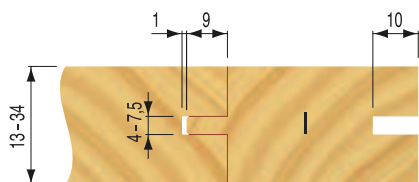

Profili – elevata profondità di incastro / Profiles - long tongue / Profilbeispiele - lange Feder

